

AMBERAIR COMPACT RIS P EKO

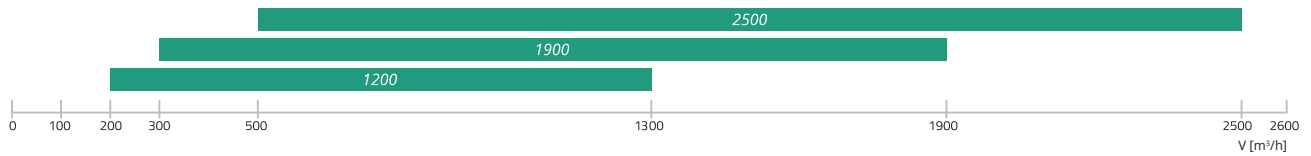

AIR HANDLING UNITS

Application	Ventilation of houses, offices or other heated premises (classrooms, apartments, conference rooms, etc.)
Description	<p>AmberAir Compact RIS P EKO 3.0 is a range of heat recovery units with high-efficiency counter-flow heat exchangers and low height. The units are designed for mounting under ceilings in order to save space. There are 3 sizes (airflow interval 1300-2500 m³/h) with separate heaters available for different climate zones. AmberAir Compact RIS P EKO 3.0 units have high overall energy savings due to the highly efficient heat recovery (up to 90%), quiet and economical EC fans, effective low-pressure-drop filters, 100% motorized bypass dampers (for the 1900 and 2500 versions) and top-level of air tightness. Energy efficiency ensures full thermal comfort for passive houses, without an additional pre-heater at temperatures above -5°C.</p> <p>All the AmberAir Compact RIS P EKO 3.0 units are fully equipped with automatic controls. Optional external sensors for CO₂ and humidity and the event planning feature will help to control automatically your climate (demand-level control).</p> <p>AmberAir Compact RIS P EKO 3.0 units are service-friendly and are easy to mount. Filter pollution identified by contamination controls.</p> <p>All units are supplied tested and ready to install.</p>
Remote control	<p>Three remote control options are available:</p> <ol style="list-style-type: none"> 1. Flex, Stouch or SA Control remote controllers. 2. Building management system connections. 3. Remote control via PC MB-Gateway.
Features	<ul style="list-style-type: none"> › Ideal for ceiling installations. › High efficiency. › Easy and quick mounting. › Water/electrical heating options. › Fully integrated plug-and-play control system.
Construction	<ul style="list-style-type: none"> › Frameless construction from double-skinned panels. › Acoustic and thermal wall insulation: 30/50 mm. › AmberAir Compact RIS 1200–2500 P EKO 3.0 powder-coated grey housing RAL 7040. › Integrated electrical heater or optional duct-based water heater/cooler. › Low-pressure-drop filters: ePM1-70 / ePM10 55. › Hinged door with locks grants easy access to internal components. › Separate compartment on the side of the unit grants quick access to the control board (plug-and-play). › Stainless steel condensate tray. › Fitted with mounting brackets. › Integrated anti-frost pressure switch.

AmberAir Compact RIS 1200 P E 0.9 EKO 3.0

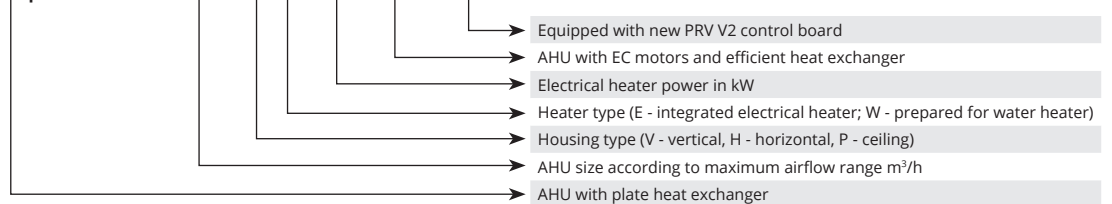

AMBERAIR COMPACT RIS P EKO

AmberAir Compact RIS 1200P EKO 3.0

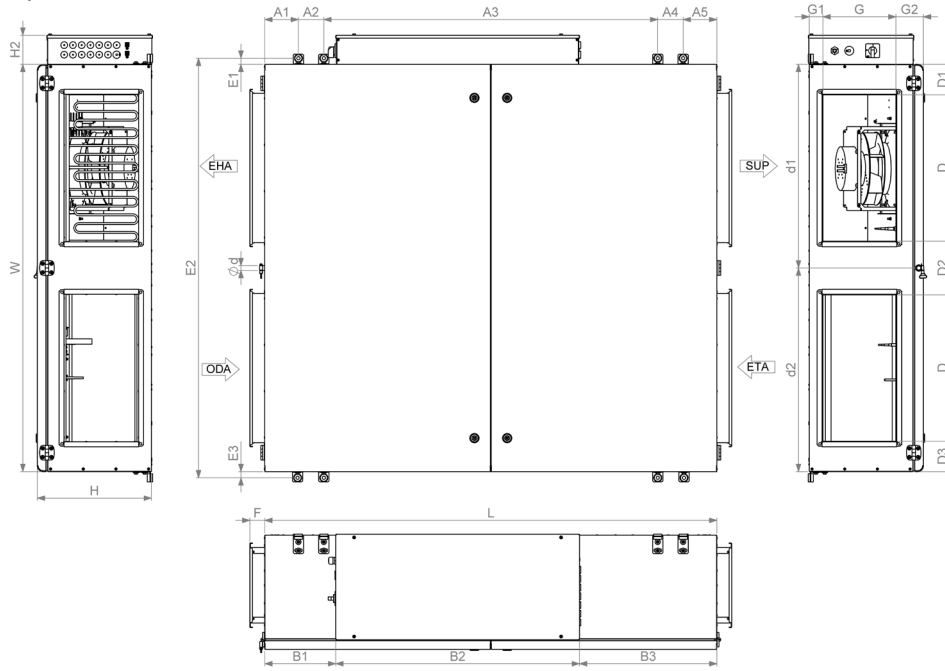

AmberAir Compact RIS 1900-2500P EKO 3.0

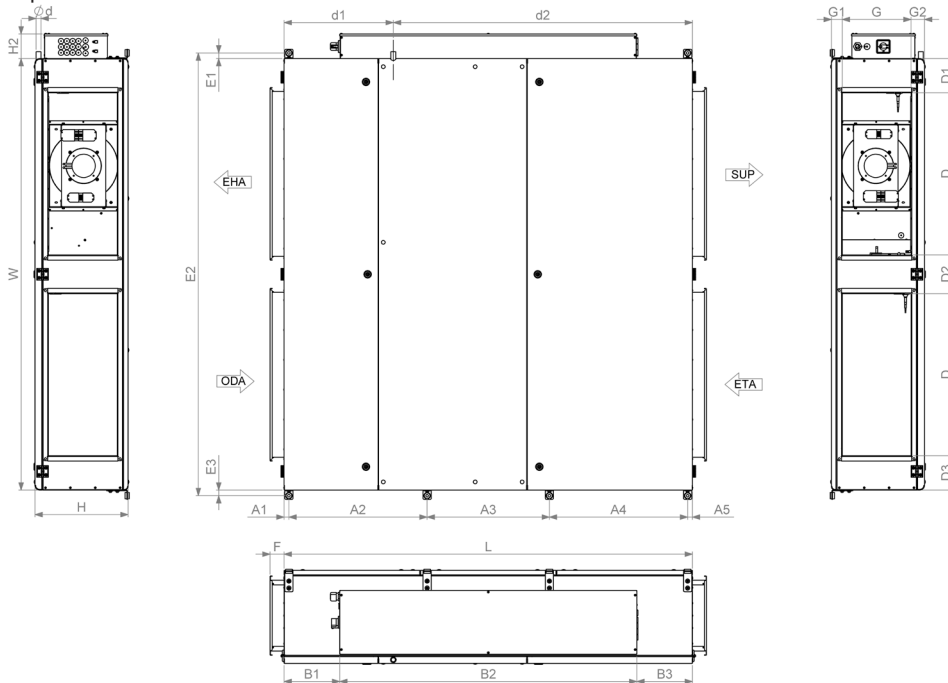

AIR HANDLING UNITS

Unit	Dimensions [mm]												
	L	W	H	D	G	Ød	F	H2	A1	A2	A3	A4	A5
AmberAir Compact RIS 1200PE/PW EKO 3.0	1550	1397	391	500	250	16	51	100	115	87	1145	87	115
AmberAir Compact RIS 1900PE/PW EKO 3.0	1750	1850	400	700	300	21,3	60	105	21	592	524	592	21
AmberAir Compact RIS 2500PE/PW EKO 3.0	1850	1950	500	700	400	21,3	60	105	21	626	558	626	21

Unit	Dimensions [mm]												
	B1	B2	B3	D1	D2	D3	E1	E2	E3	G1	G2	d1	d2
AmberAir Compact RIS 1200PE/PW EKO 3.0	246	831	473	102	180	102	21	1439	21	43	91	699	699
AmberAir Compact RIS 1900PE/PW EKO 3.0	240	1270	240	144	160	144	24	1898	24	44	55	468	1282
AmberAir Compact RIS 2500PE/PW EKO 3.0	290	1270	290	144	260	144	24	1998	24	44	55	480	1369















AMBERAIR COMPACT RIS P EKO

Unit	Optional accessories				
	Flex Stouch SA Control MB-Gateway	S-1141 S-RC02-F2 S-KFF-U	SSB Heating	SP Supply	SP Exhaust
AmberAir Compact RIS 1200PE EKO 3.0	+	+	-	LM230A-TP	LM230A-TP
AmberAir Compact RIS 1200PW EKO 3.0	+	+	161	NFA	LM230A-TP
AmberAir Compact RIS 1900PE EKO 3.0	+	+	-	LM230A-TP	LM230A-TP
AmberAir Compact RIS 1900PW EKO 3.0	+	+	161	NFA	LM230A-TP
AmberAir Compact RIS 2500PE EKO 3.0	+	+	-	LM230A-TP	LM230A-TP
AmberAir Compact RIS 2500PW EKO 3.0	+	+	161	NFA	LM230A-TP

Unit	Optional accessories				
	SVS	SSK SKS	RMG	VVP/VXP	EKS NV PH
AmberAir Compact RIS 1200PE EKO 3.0	-	500x250	-	-	500x250
AmberAir Compact RIS 1200PW EKO 3.0	500x250	500x250	+	+	500x250
AmberAir Compact RIS 1900PE EKO 3.0	-	700x400*	-	-	700x400*
AmberAir Compact RIS 1900PW EKO 3.0	700x400*	700x400*	+	+	700x400*
AmberAir Compact RIS 2500PE EKO 3.0	-	700x400	-	-	700x400
AmberAir Compact RIS 2500PW EKO 3.0	700x400	700x400	+	+	700x400

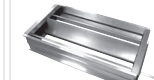
*necessary to order flange adapter STP 700x400-700x300

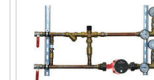
Accessories

<p>Network Module</p>  <p>MB-Gateway p. 178</p>	<p>Remote controller</p>  <p>SA Control p. 175</p>	<p>Control panel</p>  <p>FLEX p. 177</p>	<p>Remote controller</p>  <p>Stouch p. 176</p>	<p>Pressure transmitter</p>  <p>S-1141 p. 179</p>	<p>CO₂ sensor</p>  <p>S-RC02-F2 p. 180</p>	<p>Humidity sensor</p>  <p>S-KFF-U p. 181</p>	<p>Thermic water valve actuator</p>  <p>SSB p. 195</p>
<p>Actuator for dampers</p>  <p>SP p. 210</p>	<p>Water heater coil</p>  <p>SVS p. 190</p>	<p>Damper for rectangular duct</p>  <p>SSK p. 213</p>	<p>Rectangular duct silencer</p>  <p>SKS p. 215</p>	<p>Electrical duct pre-heater</p>  <p>EKS NV PH p. 203</p>	<p>Mixing point</p>  <p>RMG p. 196</p>	<p>2 and 3 way valves</p>  <p>VVP/VXP p. 197</p>	<p>Flange adapter</p>  <p>STP p. 220</p>

AMBERAIR COMPACT RIS P EKO

AmberAir Compact RIS 1200PE EKO 3.0

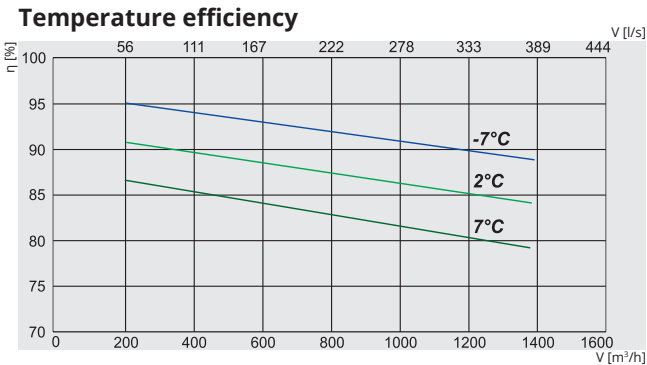
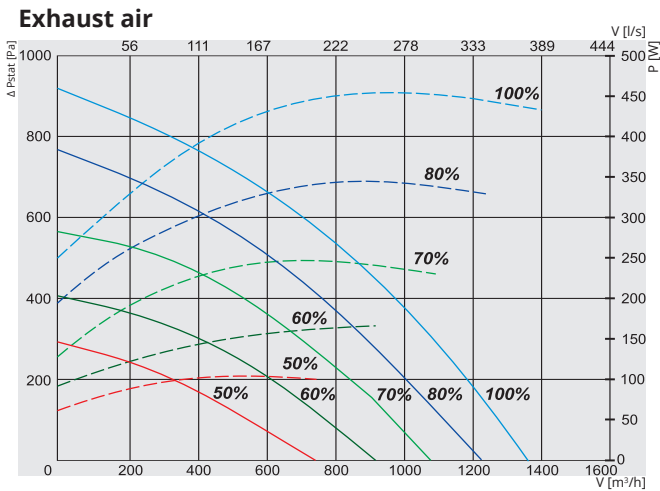
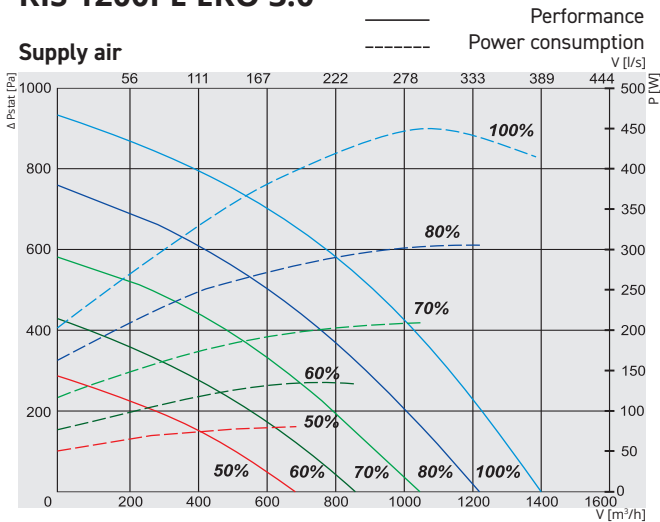

1200PE EKO 3.0

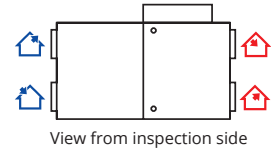

🏠 Exhaust air
 🏠 Extract air
 🏠 Outdoor air
 🏠 Supply air

Article No.	Version	Version
AHU000053	1200PE 3.0 EKO 3.0	Integrated electrical heater
AHU000054	1200PE 6.0 EKO 3.0	Integrated electrical heater
AHU000843	1200PE 9.0 EKO 3.0	Integrated electrical heater

1200PE EKO 3.0	Lwa total, dB(A)	LWA, dB(A)						
		125 Hz	250 Hz	500 Hz	1 kHz	2 kHz	4 kHz	8 kHz
Supply	76	58	69	71	69	67	64	56
Extract	64	52	56	61	56	50	45	42
Surrounding	56	42	48	50	49	48	46	40

Measured at 1298 m³/h, 100 Pa

Temperature efficiency (balanced mass flow):
 Extract air = 20°C/60%RH
 Outdoor air = -7°C / 2°C / 7°C

			3.0 EKO 3.0	6.0 EKO 3.0	9.0 EKO 3.0
Electrical heater	phase/voltage	[50Hz/VAC]	~1,230	~3,400	~3,400
		[kW]	3,0	6,0	9,0
EC fans	phase/voltage	[50Hz/VAC]	~1,230		
	exhaust power/current	[kW/A]	0,450 / 2,95		
	fan speed	[min ⁻¹]	3400		
	supply power/current	[kW/A]	0,370 / 2,5		
	fan speed	[min ⁻¹]	3400		
Thermal efficiency up to*			90%		
Motorized by-pass			+		
Max power consumption		[kW/A]	3,82 / 18,49	6,82 / 14,19	9,82 / 18,49
Control board			PRV V2		
Filter class	exhaust/supply		ePM10 55 / ePM1-70		
Housing insulation, mineral wool		[mm]	50		
Colour	RAL	grey	7040		
Weight (net, without packing)		[kg]	170		
Comply with ERP			2016; 2018		
Operation			indoors		
Fresh air temperature limits**		°C	-5 - +40		
Housing protection class		IP	34		

* Calculated wet efficiency.

** For temperatures lower than recommended, use electrical pre-heater to ensure balanced operation.

AMBERAIR COMPACT RIS P EKO

AmberAir Compact RIS 1200PW EKO 3.0

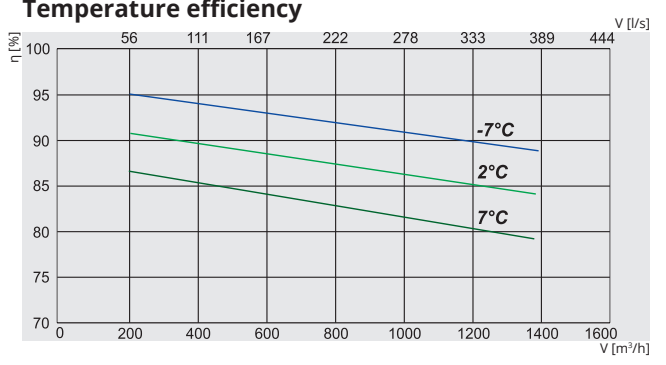
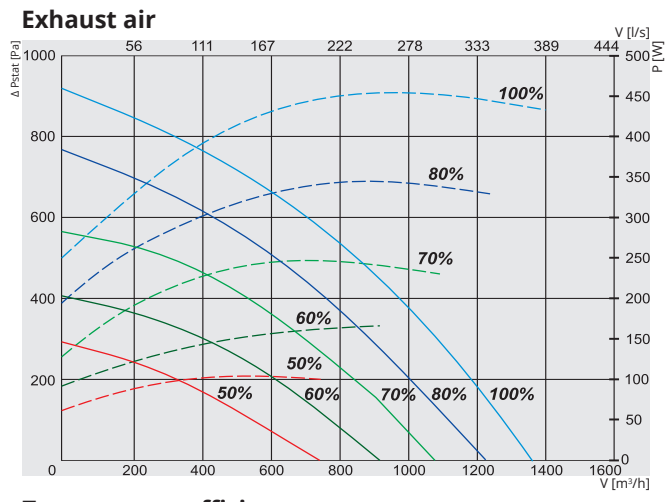
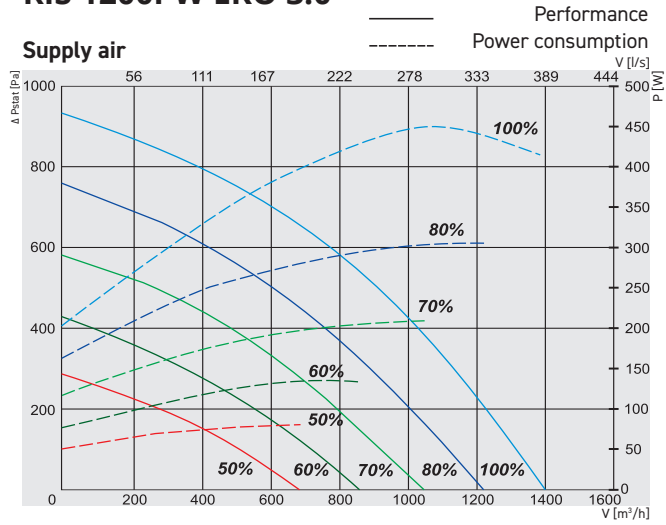

1200PW EKO 3.0

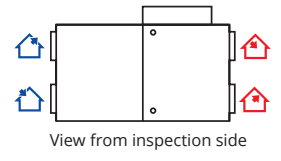

🏠 Exhaust air
 🏠 Extract air
 🏠 Outdoor air
 🏠 Supply air

Article No.	Version
AHU000055	1200PW EKO 3.0 Optional water heater

1200PW EKO 3.0	Lwa total, dB(A)	LWA, dB(A)						
		125 Hz	250 Hz	500 Hz	1 kHz	2 kHz	4 kHz	8 kHz
Supply	76	58	69	71	69	67	64	56
Extract	64	52	56	61	56	50	45	42
Surrounding	56	42	48	50	49	48	46	40

Measured at 1298 m³/h, 100 Pa

Temperature efficiency (balanced mass flow) EN :
 Extract air = 20°C/60%RH
 Outdoor air = -7°C / 2°C / 7°C

Water heater (optional)			1200PW EKO 3.0
Fans	phase/voltage	[50Hz/VAC]	SVS 500x250
exhaust	power/current	[kW/A]	~1,230
	fan speed	[min ⁻¹]	0,450 /2,95
			3400
supply	power/current	[kW/A]	0,370 /2,5
	fan speed	[min ⁻¹]	3400
Thermal efficiency up to*			90%
Motorized by-pass			+
Max power consumption		[kW/A]	0,82 /5,49
Control board			PRV V2
Filter class	exhaust/supply		ePM10 55 / ePM1-70
Housing insulation, mineral wool		[mm]	50
Colour	RAL	grey	7040
Weight (net, without packing)		[kg]	170
Comply with ERP			2016; 2018
Operation			indoors
Fresh air temperature limits**		°C	-5 - +40
Housing protection class		IP	34

* Calculated wet efficiency.
 ** For temperatures lower than recommended, use electrical pre-heater to ensure balanced operation.

AIR HANDLING UNITS

AMBERAIR COMPACT RIS P EKO

AmberAir Compact RIS 1900PE EKO 3.0

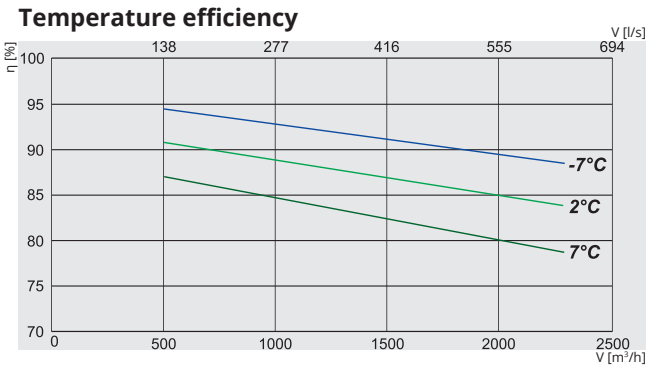
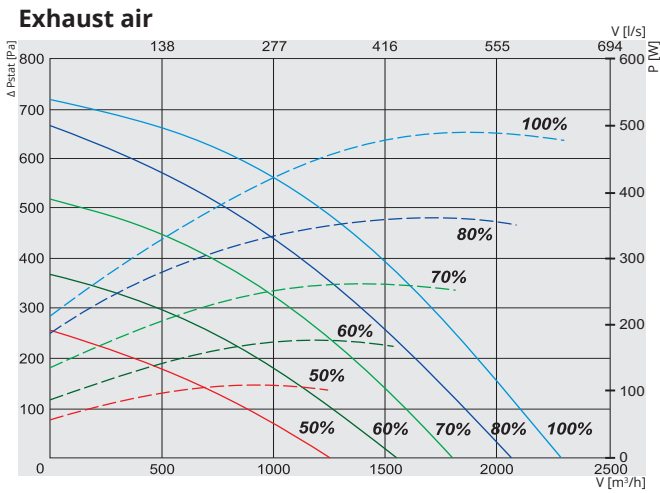
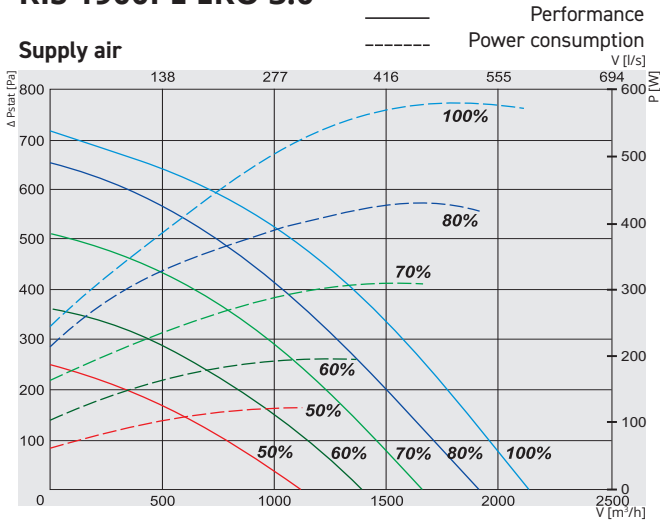

1900PE EKO 3.0

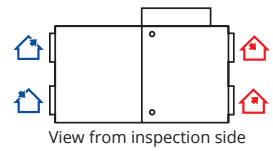

🏠 Exhaust air
 🏠 Extract air
 🏠 Outdoor air
 🏠 Supply air

Article No.	Version	Version
AHU000056	1900PE 3.0 EKO 3.0	Integrated electrical heater
AHU000057	1900PE 6.0 EKO 3.0	Integrated electrical heater
AHU000844	1900PE 12.0 EKO 3.0	Integrated electrical heater

1900PE EKO 3.0	Lwa total, dB(A)	LWA, dB(A)						
		125 Hz	250 Hz	500 Hz	1 kHz	2 kHz	4 kHz	8 kHz
Supply	77	53	64	69	73	70	65	61
Extract	68	42	58	64	62	61	58	55
Surrounding	60	50	52	54	54	50	48	41

Measured at 1938 m³/h, 100 Pa

Temperature efficiency (balanced mass flow):
 Extract air = 20°C/60%RH
 Outdoor air = -7°C / 2°C / 7°C

		3.0 EKO 3.0	6.0 EKO 3.0	12.0 EKO 3.0
Electrical heater	phase/voltage	[50Hz/VAC]	~1, 230	~3, 400
		[kW]	3,0	6,0
EC fans	phase/voltage	[50Hz/VAC]	~1, 230	
exhaust	power/current	[kW/A]	0,485 /3,12	
	fan speed	[min ⁻¹]	2540	
supply	power/current	[kW/A]	0,488 /3,16	
	fan speed	[min ⁻¹]	2540	
Thermal efficiency up to*			90%	
Motorized by-pass			+	
Max power consumption		[kW/A]	3,97 /20,32	6,97 /14,92
Control board			PRV V2	
Filter class	exhaust/supply		ePM10 55 / ePM1-70	
Housing insulation, mineral wool		[mm]	50	
Colour	RAL	grey	7040	
Weight (net, without packing)		[kg]	269	270
Comply with ERP			2016; 2018	
Operation			indoors	
Fresh air temperature limits**		°C	-5 - +40	
Housing protection class		IP	34	

* Calculated wet efficiency.

** For temperatures lower than recommended, use electrical pre-heater to ensure balanced operation.

AMBERAIR COMPACT RIS P EKO

AmberAir Compact RIS 1900PW EKO 3.0

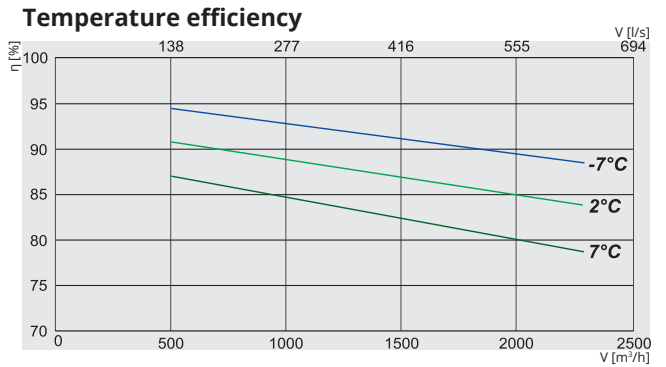
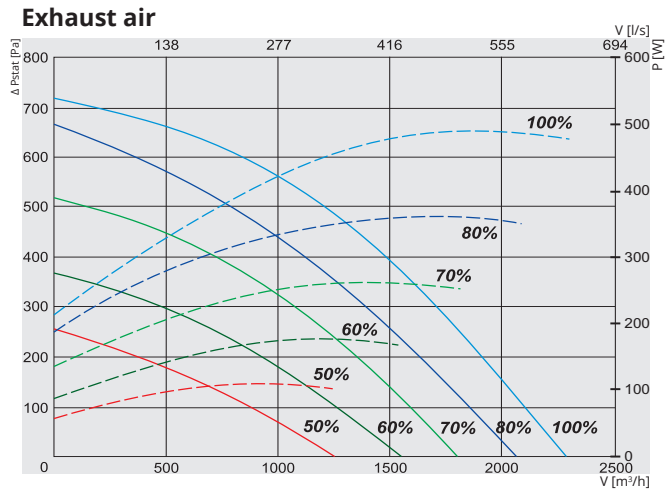
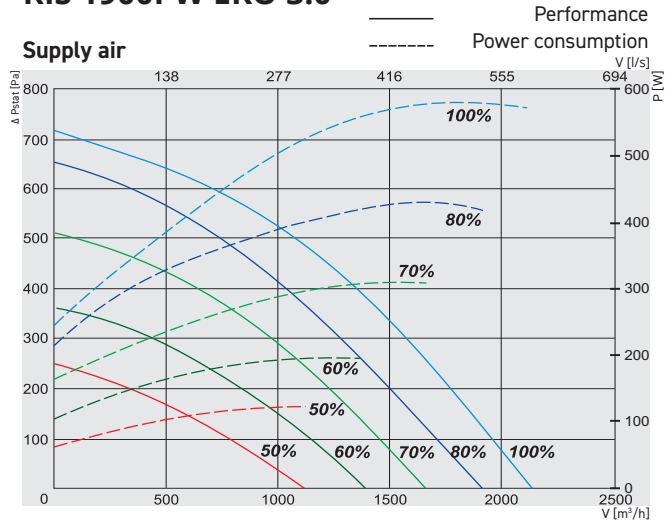

1900PW EKO 3.0

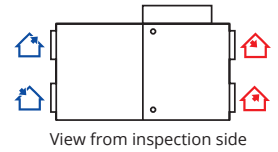

🏠 Exhaust air
 🏠 Extract air
 🏠 Outdoor air
 🏠 Supply air

Article No.	Version
AHU000058	1900PW EKO 3.0 Optional water heater

1900PW EKO 3.0	Lwa total, dB(A)	LWA, dB(A)						
		125 Hz	250 Hz	500 Hz	1 kHz	2 kHz	4 kHz	8 kHz
Supply	77	53	64	69	73	70	65	61
Extract	68	42	58	64	62	61	58	55
Surrounding	60	50	52	54	54	50	48	41

Measured at 1938 m³/h, 100 Pa

Temperature efficiency (balanced mass flow):
 Extract air = 20°C/60%RH
 Outdoor air = -7°C / 2°C / 7°C

Water heater (optional)

Fans	phase/voltage	[50Hz/VAC]	SVS 700x400
exhaust	power/current	[kW/A]	~1, 230
	fan speed	[min ⁻¹]	0,485 / 3,12
			2540
supply	power/current	[kW/A]	0,488 / 3,16
	fan speed	[min ⁻¹]	2540
Thermal efficiency up to*			90%
Motorized by-pass			+
Max power consumption	[kW/A]		0,97 / 6,32
Control board			PRV V2
Filter class	exhaust/supply		ePM10 55 / ePM1-70
Housing insulation, mineral wool	[mm]		50
Colour	RAL	grey	7040
Weight (net, without packing)	[kg]		269
Comply with ERP			2016; 2018
Operation			indoors
Fresh air temperature limits**	°C		-5 - +40
Housing protection class	IP		34

* Calculated wet efficiency.

** For temperatures lower than recommended, use electrical pre-heater to ensure balanced operation.

AMBERAIR COMPACT RIS P EKO

AmberAir Compact RIS 2500PE EKO 3.0

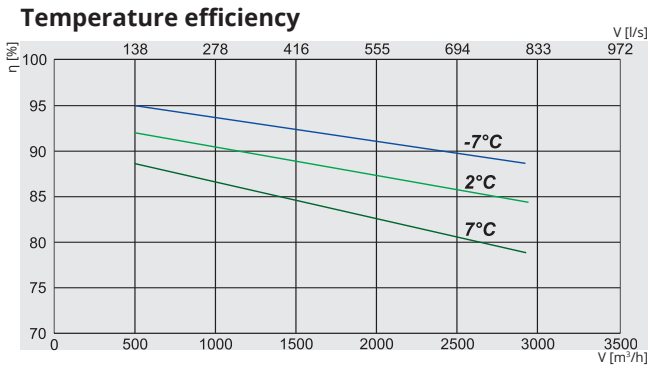
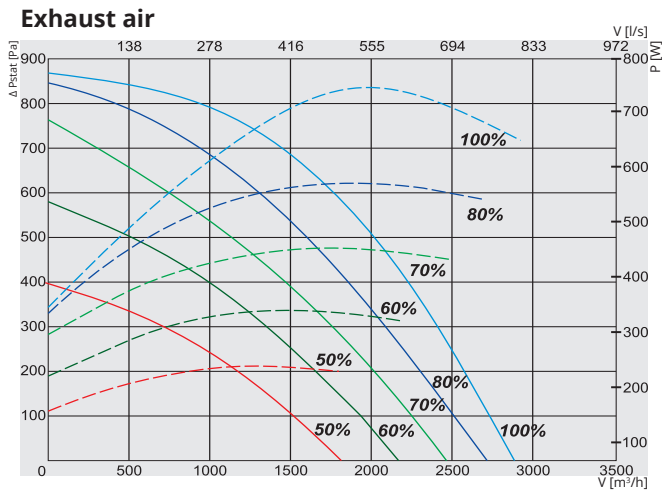
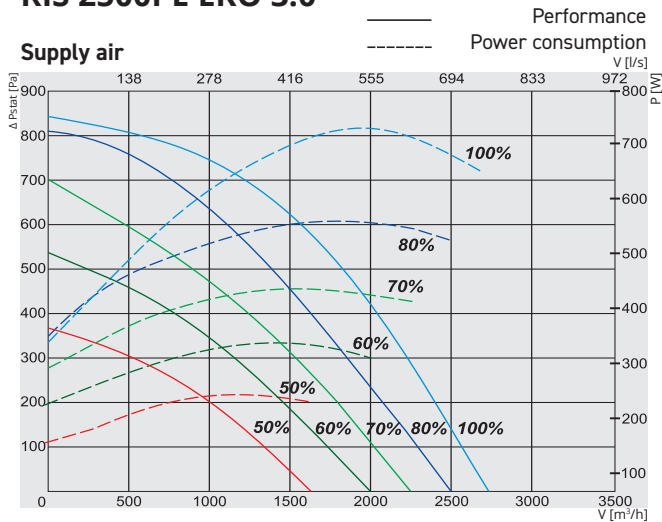

2500PE EKO 3.0

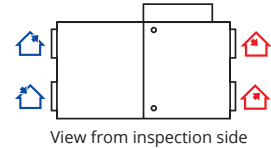

🏠 Exhaust air
 🏠 Extract air
 🏠 Outdoor air
 🏠 Supply air

Article No.	Version
AHU000059	2500PE 4.5 EKO 3.0 Integrated electrical heater
AHU000060	2500PE 9.0 EKO 3.0 Integrated electrical heater
AHU000845	2500PE 18.0 EKO 3.0 Integrated electrical heater

2500PE EKO 3.0	Lwa total, dB(A)	LWA, dB(A)						
		125 Hz	250 Hz	500 Hz	1 kHz	2 kHz	4 kHz	8 kHz
Supply	80	60	68	72	75	74	71	65
Extract	69	56	60	64	63	60	58	41
Surrounding	62	46	54	56	57	54	50	45

Measured at 2548 m³/h, 102 Pa

Temperature efficiency (balanced mass flow):
 Extract air = 20°C/60%RH
 Outdoor air = -7°C / 2°C / 7°C

			4.5 EKO 3.0	9.0 EKO 3.0	18.0 EKO 3.0
Electrical heater	phase/voltage	[50Hz/VAC]	~3, 400	~3, 400	~3, 400
		[kW]	4,5	9,0	18,0
EC fans	phase/voltage	[50Hz/VAC]	~1,230		
	exhaust power/current	[kW/A]	0,725 /3,24		
	fan speed	[min ⁻¹]	2800		
	supply power/current	[kW/A]	0,675 /3		
	fan speed	[min ⁻¹]	2800		
Thermal efficiency up to*			90%		
Motorized by-pass			+		
Max power consumption		[kW/A]	5,90 /12,78	10,40 /19,28	19,40 /32,28
Control board			PRV V2		
Filter class	exhaust/supply		ePM10 55 / ePM1-70		
Housing insulation, mineral wool		[mm]	50		
Colour	RAL	grey	7040		
Weight (net, without packing)		[kg]	322		
Comply with ERP			2016; 2018		
Operation			indoors		
Fresh air temperature limits**		°C	-5 - +40		
Housing protection class		IP	34		

* Calculated wet efficiency.

** For temperatures lower than recommended, use electrical pre-heater to ensure balanced operation.

AMBERAIR COMPACT RIS P EKO

AmberAir Compact RIS 2500PW EKO 3.0

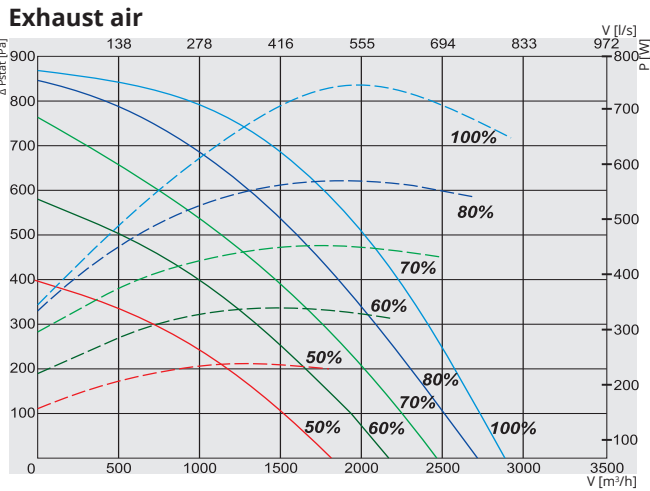
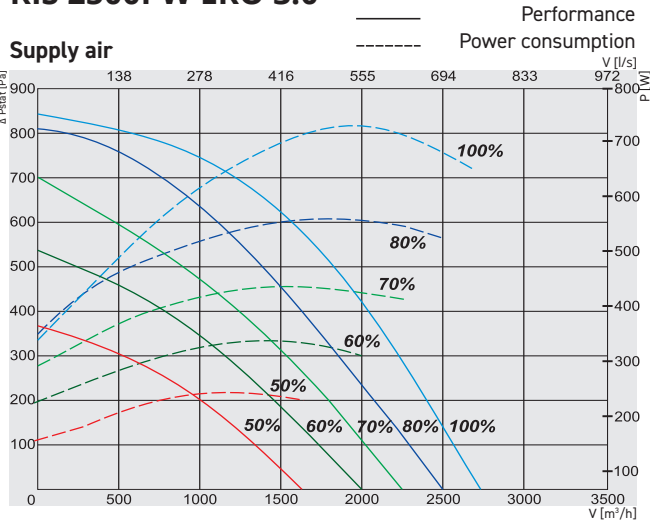

2500PW EKO 3.0

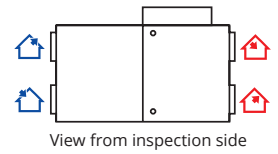

Article No.	Version	
AHU000061	2500PW EKO 3.0	Optional water heater

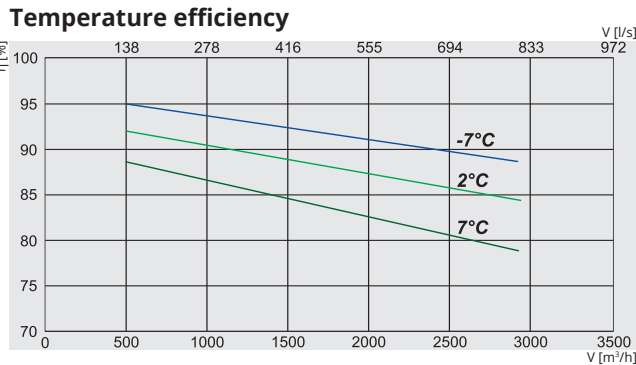

2500PW EKO 3.0	Lwa total, dB(A)		LWA, dB(A)					
	125 Hz	250 Hz	500 Hz	1 kHz	2 kHz	4 kHz	8 kHz	
Supply	80	60	68	72	75	74	71	65
Extract	69	56	60	64	63	60	58	41
Surrounding	62	46	54	56	57	54	50	45

Measured at 2548 m³/h, 102 Pa

Temperature efficiency (balanced mass flow):
 Extract air = 20°C/60%RH
 Outdoor air = -7°C / 2°C / 7°C

Water heater (optional)	phase/voltage	[50Hz/VAC]	
Fans	phase/voltage	[50Hz/VAC]	
exhaust	power/current	[kW/A]	0,725 / 3,24
	fan speed	[min ⁻¹]	2800
supply	power/current	[kW/A]	0,675 / 3
	fan speed	[min ⁻¹]	2800
Thermal efficiency up to*			90%
Motorized by-pass			+
Max power consumption		[kW/A]	1,40 / 6,28
Control board			PRV V2
Filter class	exhaust/supply		ePM10 55 / ePM1-70
Housing insulation, mineral wool		[mm]	50
Colour	RAL	grey	7040
Weight (net, without packing)		[kg]	322
Comply with ERP			2016; 2018
Operation			indoors
Fresh air temperature limits**		°C	-5 - +40
Housing protection class		IP	34

* Calculated wet efficiency.

**For temperatures lower than recommended, use electrical pre-heater to ensure balanced operation.

AMBERAIR COMPACT RIS P EKO

AmberAir Compact RIS 1200PE EKO 3.0 / 1900PE EKO 3.0 / 2500PE EKO 3.0 (ceiling mounted) versions with electrical heater

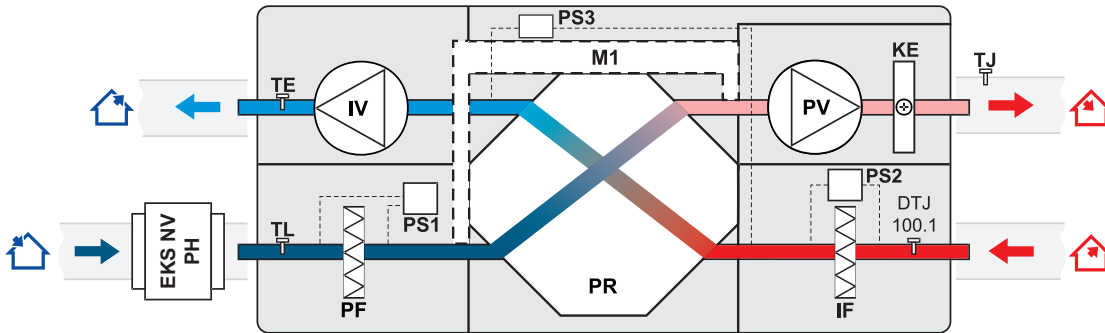

- IV - exhaust air fan
- PV - supply air fan
- PR - plate heat exchanger
- KE - electrical heater
- PF - filter for supply air (class ePM1-70)
- IF - filter for extract air (class ePM10 55)
- TE - temperature sensor for exhaust air
- TL - temperature sensor for fresh air
- EKS NV PH - optional fresh air pre-heater
- DTJ 100.1 - humidity + temperature sensor
- TJ - temperature sensor for supply air
- M1 - actuator of by-pass damper
- PS1 - supply air differential pressure switch
- PS2 - extract air differential pressure switch
- PS3 - heat exchanger antifrost pressure switch

AmberAir Compact RIS 1200PW EKO 3.0 / 1900PW EKO 3.0 / 2500PW EKO 3.0 (ceiling mounted) versions with water heater

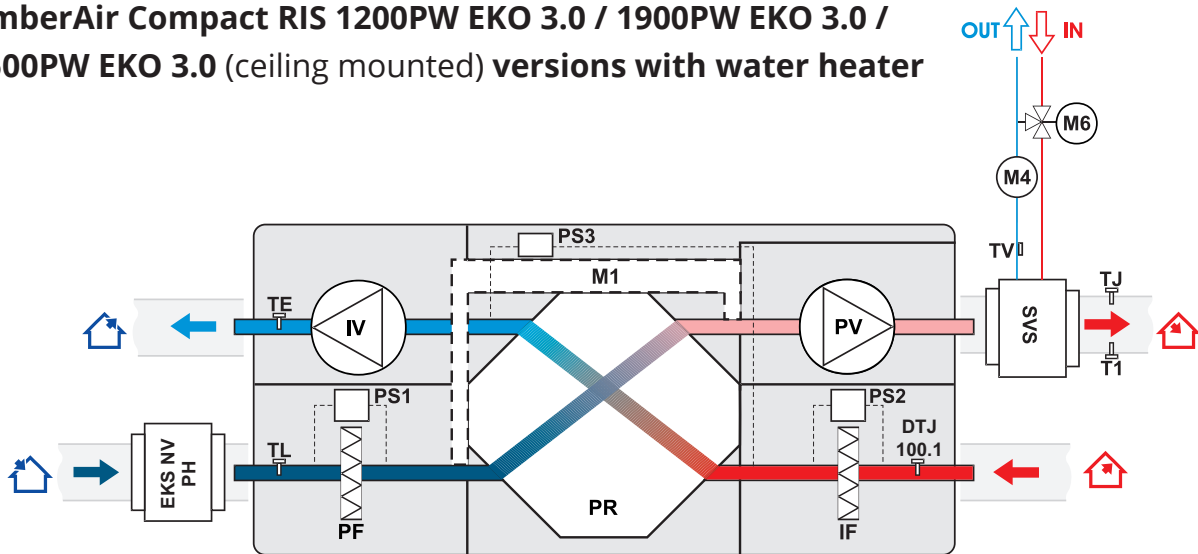

- IV - exhaust air fan
- PV - supply air fan
- PR - plate heat exchanger
- PF - filter for supply air (class ePM1-70)
- IF - filter for extract air (class ePM10 55)
- TE - temperature sensor for exhaust air
- TL - temperature sensor for fresh air
- TJ - temperature sensor for supply air
- T1 - antifrost thermostat
- TV - antifrost sensor
- DTJ 100.1 - humidity + temperature sensor
- M1 - actuator of by-pass damper
- M4 - water heater circulation pump
- M6 - optionally supplied mixing valve and motor
- PS1 - supply air differential pressure switch
- PS2 - extract air differential pressure switch
- PS3 - heat exchanger antifrost pressure switch
- SVS - optionally supplied water heater
- EKS NV PH - optional fresh air heater

AIR HANDLING UNITS

AMBERAIR COMPACT RIS P EKO

FUNCTIONS			
Description of the functions	Functions	PRV V2	
		AmberAir Compact RIS EKO 3.0	
		E	W
	Date and time settings	✓	✓
	4 speeds for easy and user-friendly control (“Stop” – the unit is stopped; “Low”, medium”, and “High”. Service menu allows adjusting each speed individually)	✓	✓
	BOOST function (Fans operate at highest speed)	✓	✓
	Comfortable air temperature function	✓	✓
	Cold/heat recovery	✓	✓
	Fire place function	✓	✓
	Dryness protection	✓	✓
	Weekly schedule	✓	✓
	Holiday schedule	✓	✓
	User and service control levels	✓	✓
	Manual air flow balancing	✓	✓
	CO₂ level indication and reduction function	✓	✓
	Night cooling function	✓	✓
	Relative humidity (RH) level indication and reduction function	✓	✓
	Software and configuration update possibility	✓	✓
	Supply air temperature control according to the extract air sensor	✓	✓
	Monitoring function (all sensors and I/O)	✓2	✓2
	Mode switch (start/stop)	✓	✓
	Extracted air relative humidity converter	✓	✓
	Manual components control	✓1	✓1
	Functional units		
Fans			
	Soft start and stop	✓	✓
	Fan failure protection	✓	✓
	Speed synchronous/asynchronous 0-10V control	✓	✓
Electric heater			
	On/Off / PWM control	✓	
	Manual protection	✓	
	Overheat protection (additional protection software)	✓	✓
Water heater			
	Pulse-width modulation (PWM) valve actuator control		✓
	Protection using temperature sensor		✓
	Protection using thermostat (NC)		✓
	Circulation pump control		✓
	Return water temperature sensor	✓	✓
DX cooler			
	Control On/Off	✓	✓
Water cooler			
	Pulse-width modulation (PWM) valve actuator control		✓
	Control with three-positional valve actuator	✓	✓
Bypass damper			
	3-position actuator control	✓	✓
Filter pollution monitoring			
	By pressure switch (NC)	✓	✓
	By filter timer	✓	✓
Sensors			
	Supply air temperature sensor	✓	✓
	Fresh air temperature sensor	✓	✓
	Exhaust air temperature sensor	✓	✓
	Extract air temperature sensor	✓	✓
	Emergency signals and inputs/outputs		
	Fire protection input	✓	✓
	Working indication output	✓	✓
	Alarm indication output	✓	✓
	Remote controllers		
	Stouch	✓	✓
	Flex	✓	✓
	SA Control	✓	✓
	MB-Gateway	✓	✓

1 With FLEX TEST remote controller

2 Only sensors